

MASTERPIUMA **3** LA PROFESSIONALE  
*The professional choice*

# MASTERPIUMA 3 LA COMPLETA

*The full optional*

Incisione ergonomica a spinta  
*Ergonomic Push incision*

Massima precisione  
*Maximum precision*

Lubrificazione integrata  
*Integrated lubrication point*

Incisione assistita da 0 a 22 mm  
*Incision assistance from 0 to 22 mm*

100% materiale riciclabile  
*100% recycled material*

Telaio a scatola rinforzato  
*Reinforced frame*

Piedoni antiscivolo  
*Non-slip feet*

Piani in acciaio molleggiati  
*Sprung metal support tables*

Braccio estensibile per grandi formati  
*Extension arm for supporting big tiles*

Squadretta di riferimento ribaltabile  
*Measurement square flips out of way if not required*



Ammortizzatore  
*Shock absorber (bumper)*

Box per rotelle  
*Box for spare incision wheel*

Rotazione squadra  $-45^\circ \div +45^\circ$   
*Square rotation  $-45^\circ \div +45^\circ$*

Doppia scala graduata a "lente"  
*Dual millimeter scale - "lens effect"*

Squadra goniometrica rinforzata  
*Reinforced Geometric square*



# MASTERPIUMA 3 LA VERSATILE

*The multipurpose*

- 1 Incisione ergonomica a spinta  
*Ergonomic Push incision*
- 2 Ammortizzatore  
*Shock absorber (bumper)*
- 3 Massima precisione  
*Maximum precision*
- 4 Piedoni antidrucciolo  
*Non-slip feet*
- 5 Cambio rapido della rotella di incisione  
*Quick & easy change cutting wheel*
- 6 Doppio spacco "pulito"  
*Dual splitting device*
- 7 Multifunzione: ideale per ceramica, vetro e mosaico  
*Multifunctional & ideal for ceramic, glass and mosaic*
- 8 Rotella di incisione a vista titanium gold  
*High visibility of incision wheel*

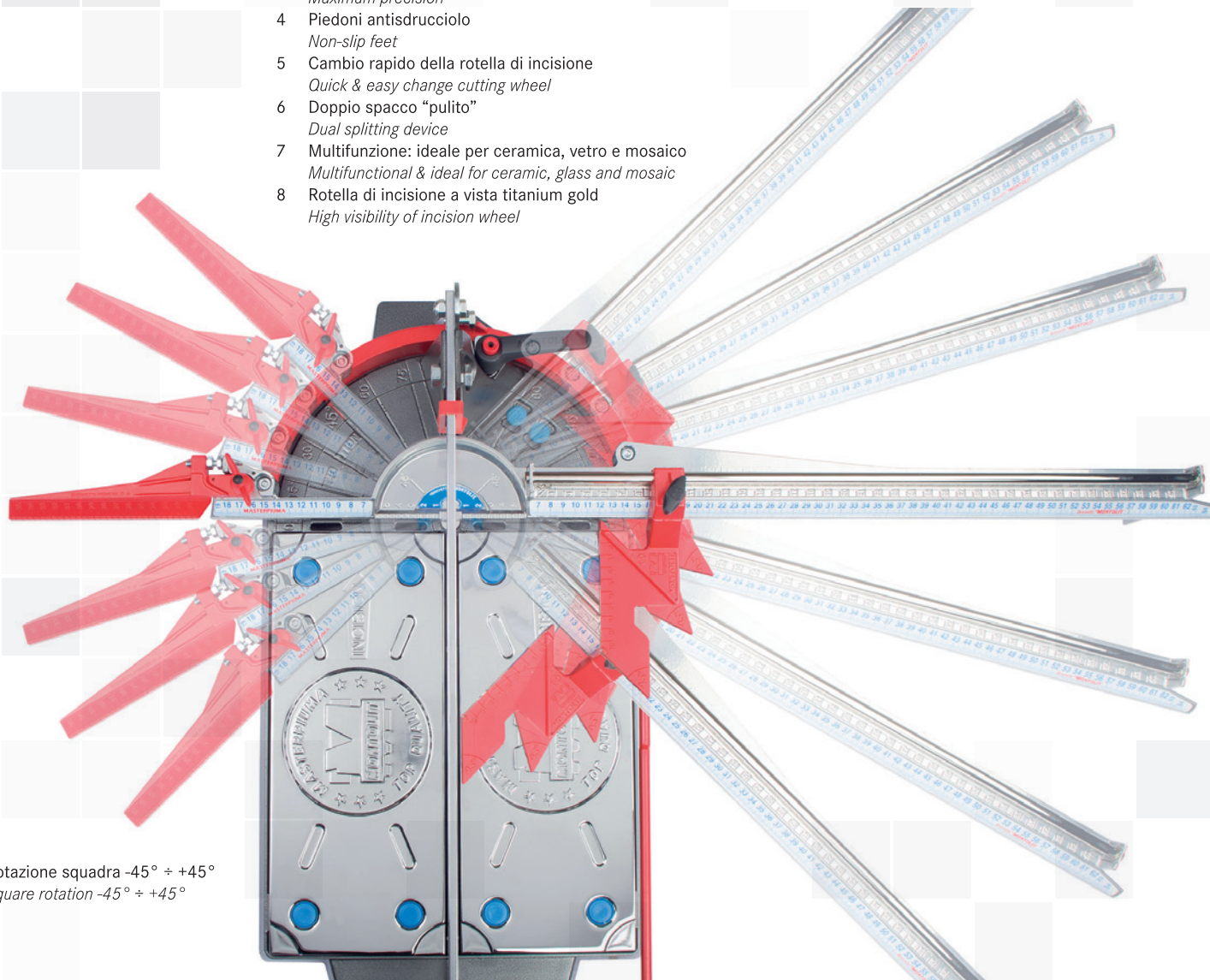

Rotazione squadra  $-45^\circ \div +45^\circ$   
*Square rotation  $-45^\circ \div +45^\circ$*

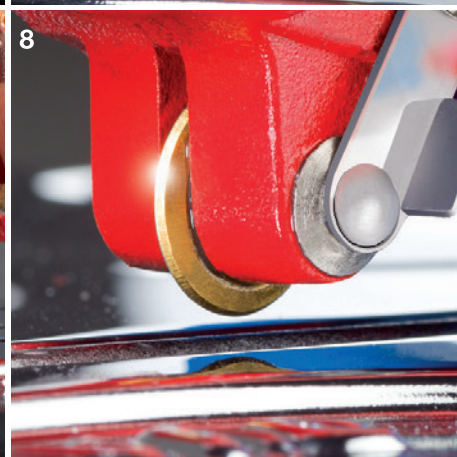
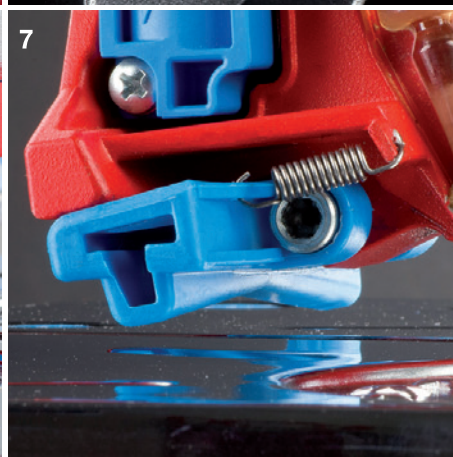
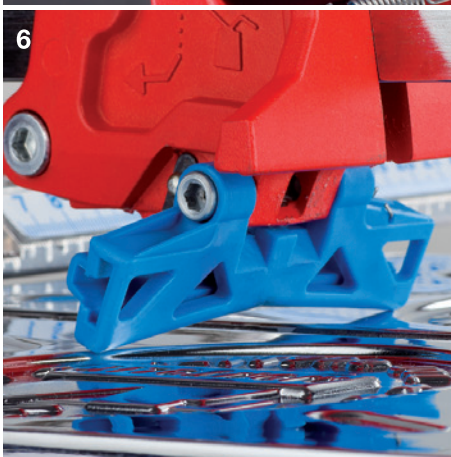
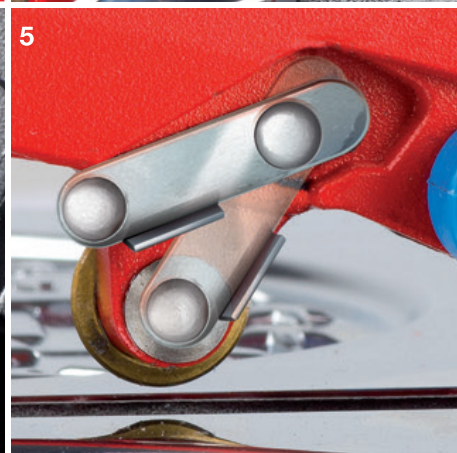

# MASTERPIUMA 3 LA COMPATTA

*All in One System*

- 9 Squadretta di riferimento ribaltabile  
*Measurement square - flips out of way if not required*
- 10 Piani in acciaio molleggiati  
*Sprung metal support tables*
- 11 Box per rotelle  
*Box for spare incision wheel*
- 12 Doppia scala graduata a "lente"  
*Dual millimeter scale - "lens effect"*
- 13 Telaio a scatola rinforzato  
*Reinforced frame*
- 14 Lubrificazione integrata  
*Integrated lubrication point*
- 15 Incisione assistita da 0 a 22 mm  
*Incision assistance from 0 to 22 mm*
- 16 Braccio estensibile per grandi formati  
*Extension arm for supporting big tiles*

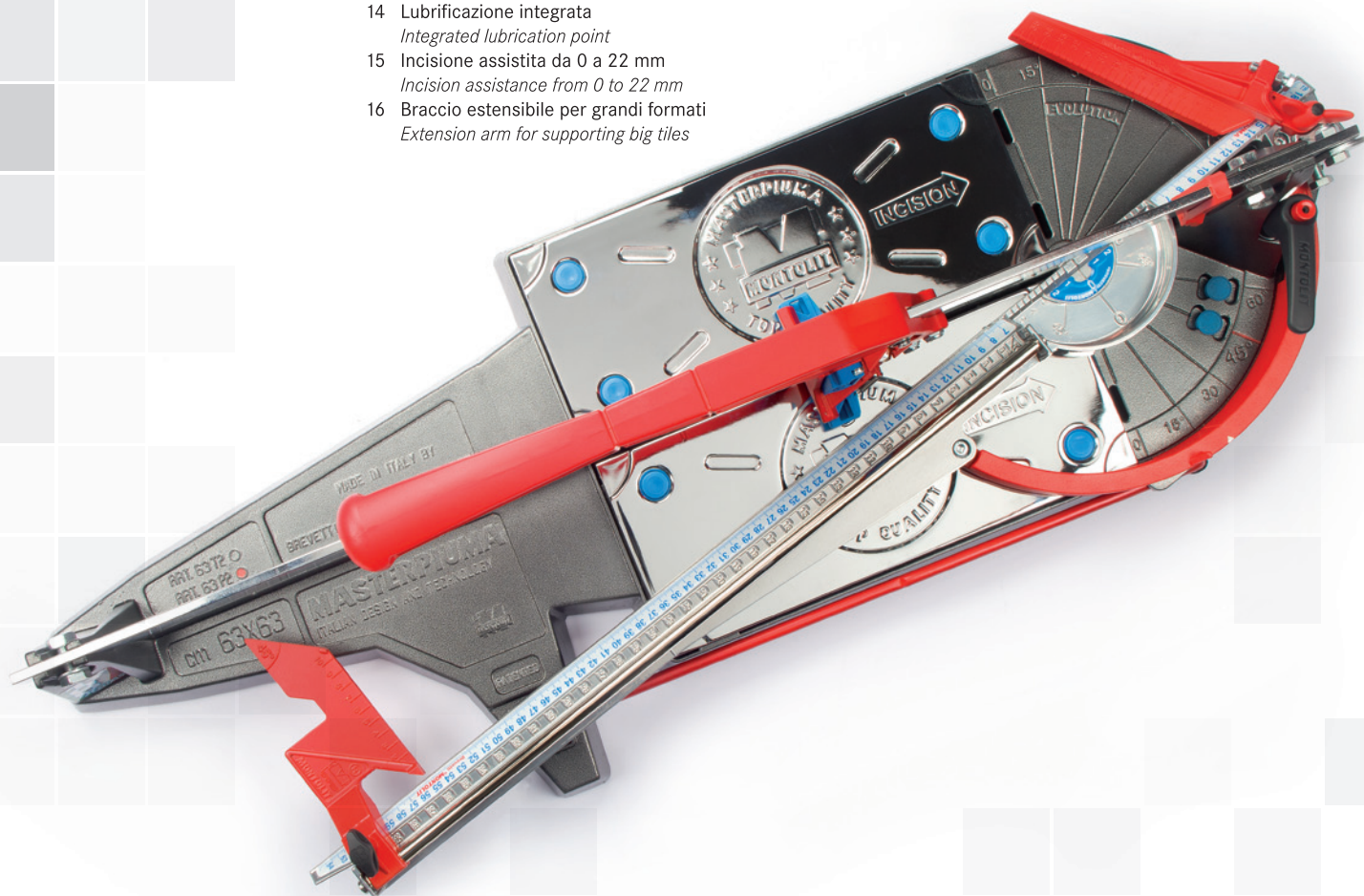

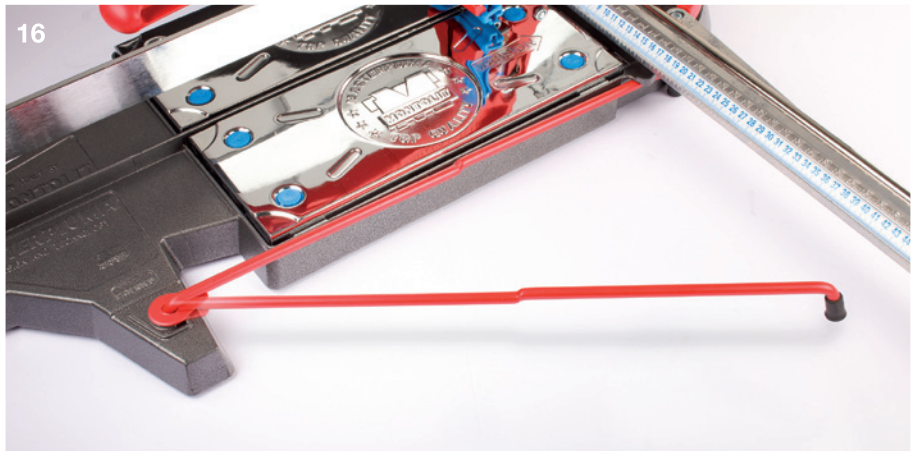
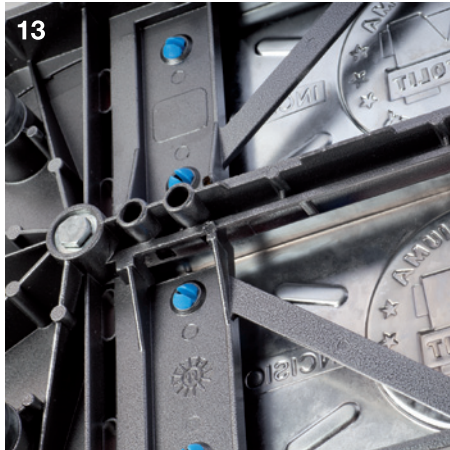
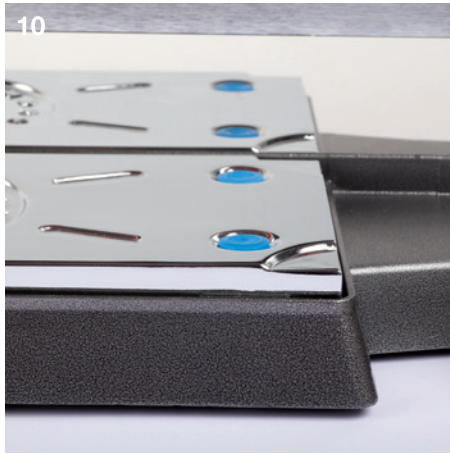
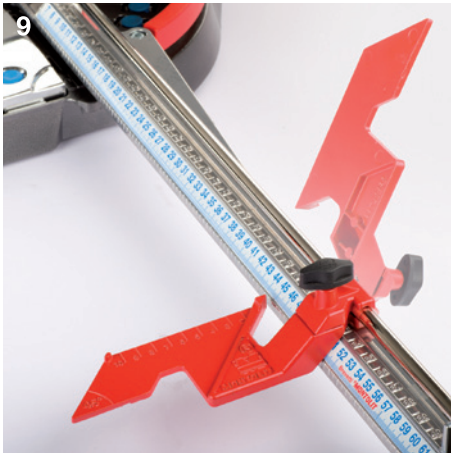

# MASTERPIUMA 3 ACCESSORI

*Accessories*

## 17 - BASEBOARD ART. 64

Riferimento aggiuntivo per grandi formati ideale per il taglio di listelli e di battiscopa.

*Bracket precision for cutting strip tiles and skirting boards.*

## 18 - PIEDONE ART. 449P

Sistema di spacco supplementare per piastrelle di grandi dimensioni (fino a 155 cm) e gres porcellanato spessorato (max 2 cm).

*Additional splitting system for extra large tiles size (up to 155 cm) and porcelain tile thickness (max 2 cm).*

## 19 - MOSAKIT ART. 58

Tappetino di gomma vulcanizzata che viene posizionato sulla taglia piastrelle manuale e permette di incidere e dividere mosaici montati su carta o retina senza danneggiare il mosaico stesso.

*Vulcanized rubber pad that is placed on manual tilecutters and allows to cut and divide mosaics on paper or retina without damaging the mosaic itself.*

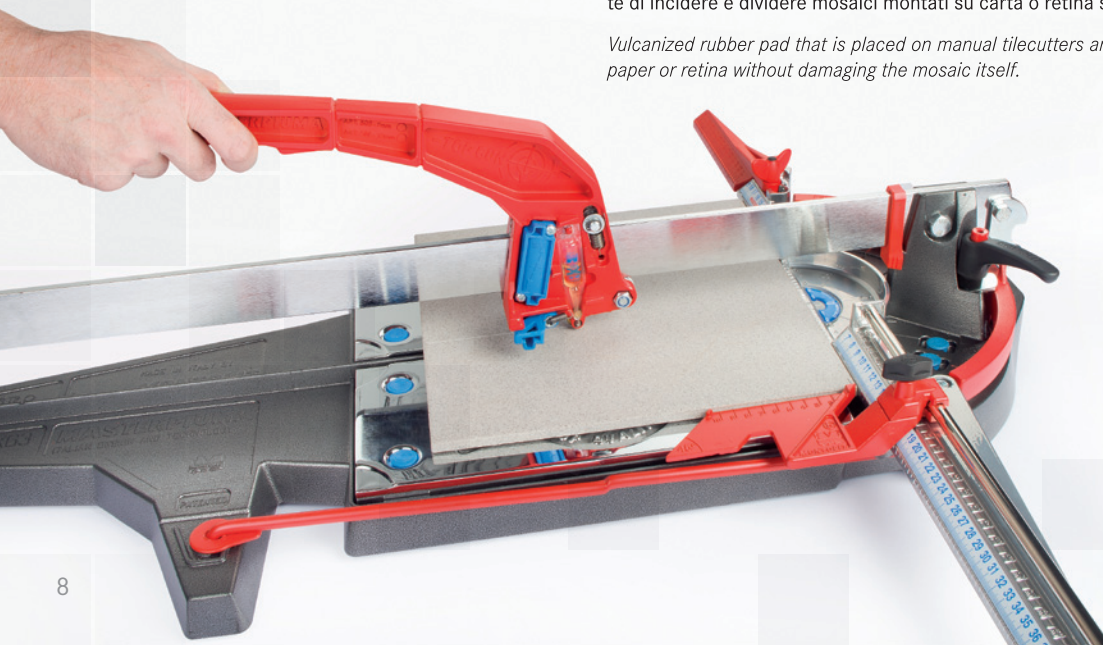



17



18





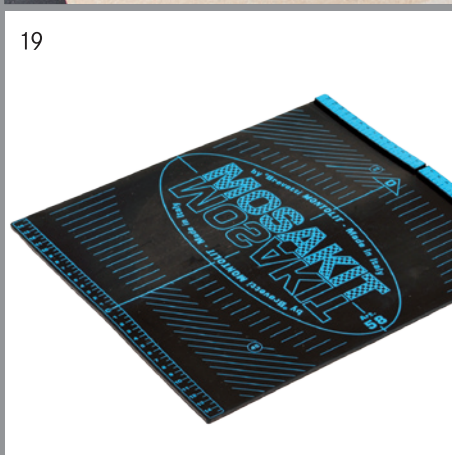

19



# MASTERPIUMA 3 DATI TECNICI

*Technical data*

| ART.  | <br>cm (inch) | <br>cm (inch) | <br>cm (inch) | <br>Kg |
|-------|--|--|---|---|
| 44P3  | 44 (17")   | 31 x 31 (12"x12")  | 0 ÷ 2 (0 ÷ 3/4)   | 7,7   |
| 52P3  | 52 (20")   | 37 x 37 (14"x14")  | 0 ÷ 2 (0 ÷ 3/4)   | 8,2   |
| 63P3  | 63 (24,5")   | 44 x 44 (17"x17")  | 0 ÷ 2 (0 ÷ 3/4)   | 9,5   |
| 75P3  | 75 (29")   | 53 x 53 (21"x21")  | 0 ÷ 2 (0 ÷ 3/4)   | 11,8  |
| 93P3  | 93 (36")   | 66 x 66 (26"x26")  | 0 ÷ 2 (0 ÷ 3/4)   | 13,0  |
| 125P3 | 125 (49")  | 88 x 88 (34,5"x34,5")  | 0 ÷ 2 (0 ÷ 3/4)   | 24,0  |
| 155P3 | 155 (61")  | 109 x 109 (43"x43")  | 0 ÷ 2 (0 ÷ 3/4)   | 33,0  |

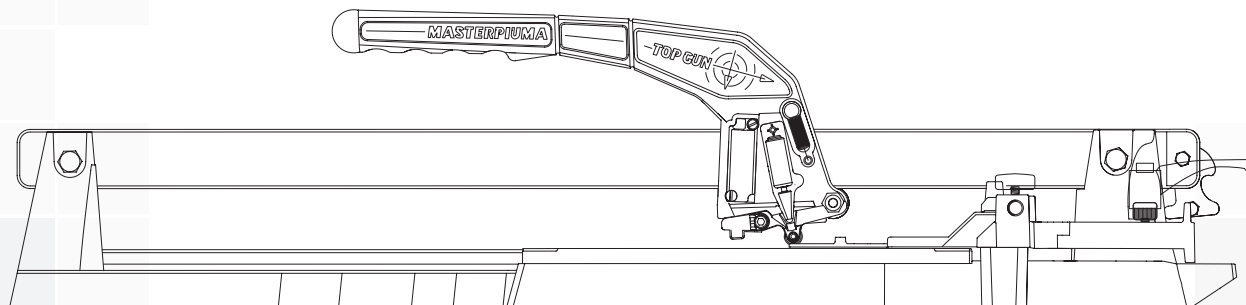

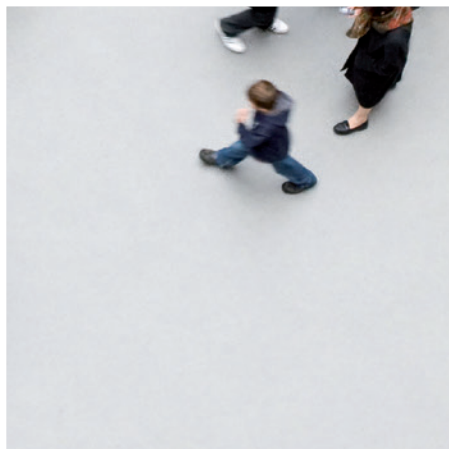
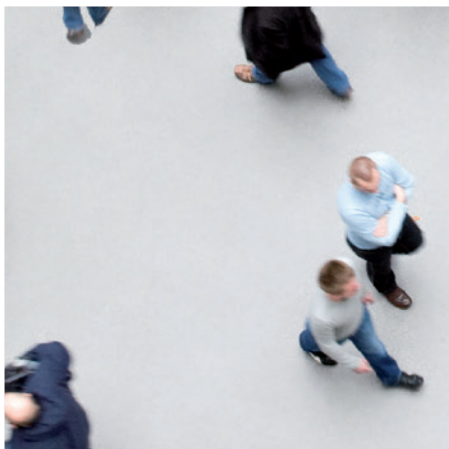
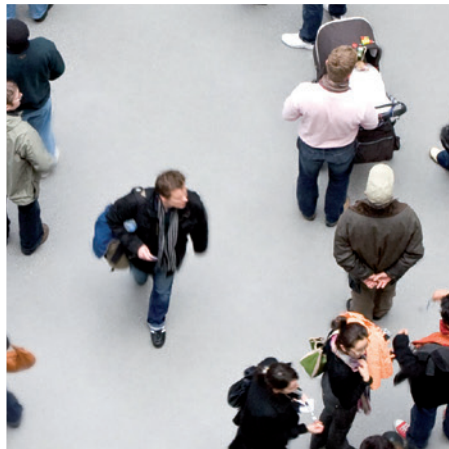
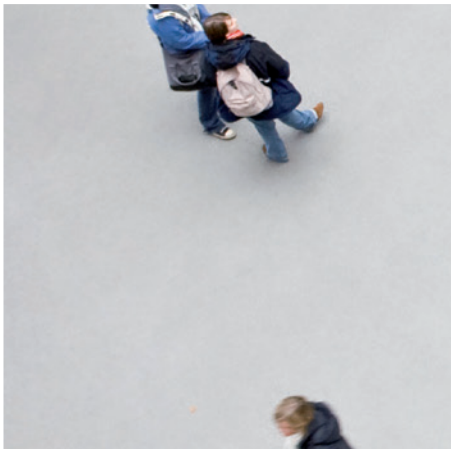



**Brevetti Montolit SpA**

Sede operativa:  
Via Varese 4/A - 21050 Cantello (VA) Italy

Sede legale:  
Via Turconi, 25 - 21050 Cantello (VA) Italy

Tel. ++39 0332 419 211

Fax ++39 0332 418 444

[www.montolit.com](http://www.montolit.com)

[info@montolit.com](mailto:info@montolit.com)